

DRAWING FOR CUSTOMER

- SPEC.:
- Rated Voltage:250V AC,DC
 - Rated Current:5A AC,DC
 - Withstand Voltage:1500V AC/minute
 - Contact Resistance:15mΩ max
 - Insulation Resistance:1000MΩ min
 - Temperature Range:-25°C~+85°C

- Material:
- Insulator:PA66 UL94 V-2
 - Color:WH-White
BK-Black

KB9301-D X X H L 6 A-XX

Double row
Pin No.
Housing
With Lock

Color
Version
Mold No.

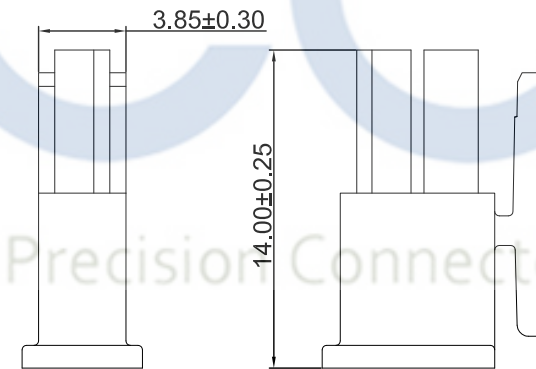
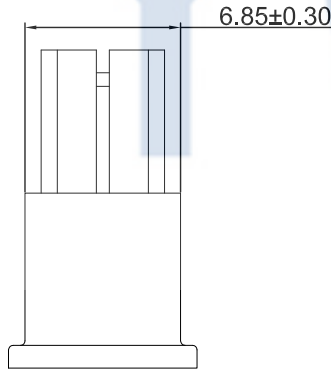
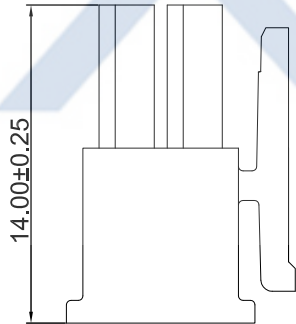
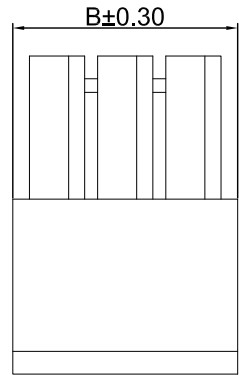
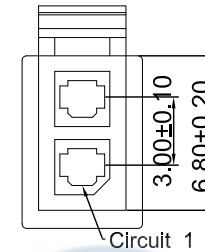
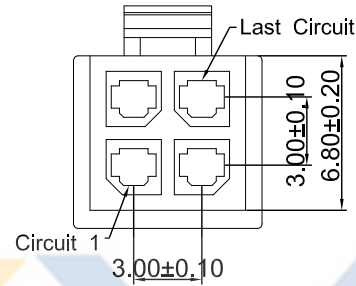
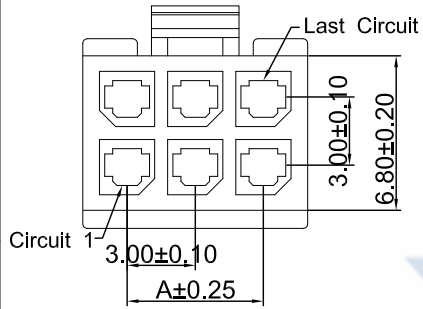

2x3P-2X12P

2x2P
2*1X2*2P有筋

2x1P

Poles	Dimensions(mm)	
	A	B
2x01	---	3.85
2x02	3.00	6.85
2x03	6.00	9.90
2x04	9.00	12.90
2x05	12.00	15.90
2x06	15.00	18.90
2x07	18.00	21.90
2x08	21.00	24.90
2x09	24.00	27.90
2x10	27.00	30.90
2x11	30.00	33.90
2x12	33.00	36.90

XYCO 东莞市轩业电子科技有限公司
TEL: 0769-8297 9981/2/3 http://www.XYCO.com.cn

DATE 日期	VER 版本	CHANGE HISTORY 變更歷史	CHANGED NAME 修改後料號	DRAWING 變更者
2015-10-16	A		KB9301-DXXHL6A-XX	Devin

TOLERANCE 公差	DRAWING 設計者	Devin	KB9301-DXXHL6A-XX	
.X=±0.30	CHECKED 審查	Thomas	PART NO. 料號	
.XX=±0.20	APPROVED 核准	William	DWG NO. 圖號	PE2109014A
.XXX=±0.10				

UNIT 單位	mm	PRODUCT NAME 產品名稱
		43025 PH3.0mm Wire To Wire Dual row Housing with lock-Male