

DRAWING FOR CUSTOMER

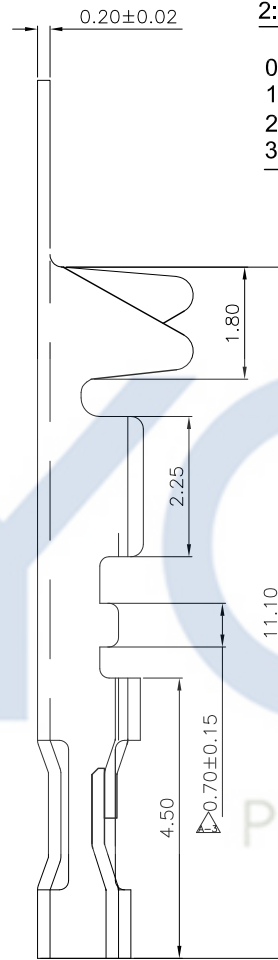
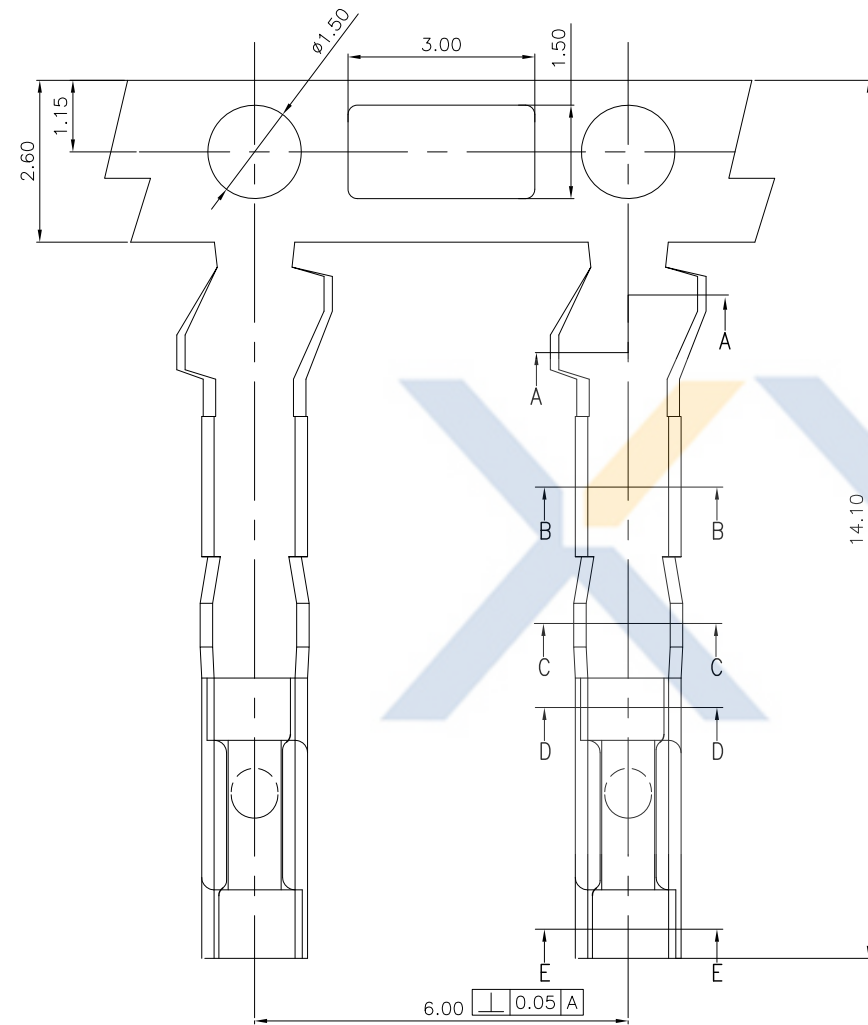

KB951-XXT1A

1: All plated
2: Half plated

0: Tin-plat
1: Gold Plat1u"
2: Gold Plat3u"
3: Gold Plat5u"

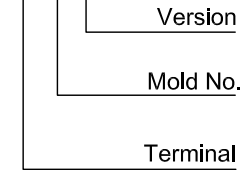

- SPEC.:
- Rated Voltage:250V AC,DC
 - Rated Current:3A AC,DC
 - Withstand Voltage:800V AC/minute
 - Contact Resistance:20mΩ max
 - Insulation Resistance:1000MΩ min
 - Temperature Range:-25℃~+85℃

- Terminal:
- Material:Brass
 - Finish: Tin-plated, over Nickel
 - Applicable wire:AWG#22~26
 - QTY.:10KPCS/Reel

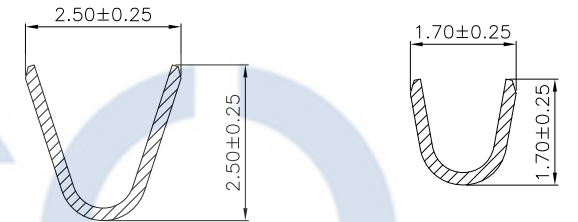

Section:A-A

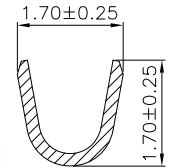

Section:B-B

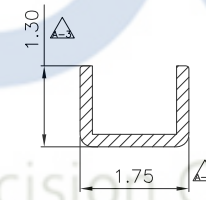

Section:C-C

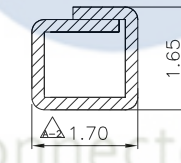

Section:D-D

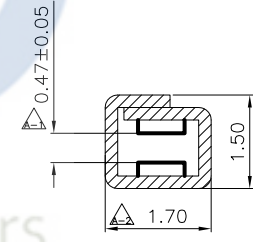

Section:E-E

2017-12-10	A-3	增加卡槽卡点尺寸管控, 优化产品	KB951-XXT1A	Devin
2017-07-15	A-2	方形口宽度由L=1.60mm变更为L=1.70mm.	KB951-XXT1A	Devin
2017-04-02	A-1	夹口变更由L=0.50mm为L=0.47mm优化产品.	KB951-XXT1A	Devin
2013-05-27	A		KB951-XXT1A	Devin
DATE 日期	VER 版本	CHANGE HISTORY 變更歷史	CHANGED NAME 修改後料號	DRAWING 變更者

TOLERANCE 公差	DRAWING 設計者	Devin	KB951-XXT1A	
.X=±0.30 .XX=±0.20 .XXX=±0.10	CHECKED 審查	Thomas	PART NO. 料號	
	APPROVED 核准	William	DWG NO. 圖號	PE1808005A

XYCO 东莞市轩业电子科技有限公司
TEL: 0769-8297 9981/2/3 <http://www.XYCO.com.cn>

UNIT 單位	mm	PRODUCT NAME 產品名稱	DUPONT PH2.54mm Wire To Board Terminal
------------	----	----------------------	--